

TOMADA E PLUG

TMD e PLG

Tomadas e plugs para uso em áreas classificadas com atmosferas explosivas.

Disponíveis em 16, 32 e 63A.

Tomada industrial com chave de intertravamento mecânico.

Corpo em poliéster com fibra de vidro.



CARACTERÍSTICAS TÉCNICAS

Marcação:

Poeiras: Ex tb IIIC T85°C Db

Normas Aplicáveis:

ABNT NBRIEC 60079-0

ABNT NBRIEC 60529

ABNT NBRIEC 60079-31

Zonas:

21 ou 22

| | | | |
|---------|------------------------|----|---|
| Poeiras | Atmosfera Intermitente | 21 | ☑ |
| | Condições Anormais | 22 | ☑ |

Grupos

Poeiras Inflamáveis

| | | |
|------|------------------------|---|
| IIIA | Fibras Combustíveis | ☑ |
| IIIB | Poeiras Não Condutivas | ☑ |
| IIIC | Poeiras Condutivas | ☑ |

MATERIAIS

| | | Número de Pólos | | Tensão | Código Tomada | Código Plugue | |
|-------------|-----------------|-----------------|------------|--------|---------------|---------------|---------|
| | | Quantidade | Ilustração | | | | |
| 16 A | CORRENTE | | 2P+T | | 110-130 | TMD-A3Y | PLG-A3Y |
| | | | | | 200-250 | TMD-A4Y | PLG-A4Y |
| | | | | | 380-415 | TMD-A5Y | PLG-A5Y |
| | | | 3P+T | | 200-250 | TMD-A4X | PLG-A4X |
| | | | | | 380-415 | TMD-A5X | PLG-A5X |
| | | | | | 480-500 | TMD-A6X | PLG-A6X |
| | | | 3P+T+N | | 200-250 | TMD-A4W | PLG-A4W |
| | | | | | 380-415 | TMD-A5W | PLG-A5W |
| | | | | | 480-500 | TMD-A6W | PLG-A6W |
| 32 A | CORRENTE | | 2P+T | | 110-130 | TMD-B3Y | PLG-B3Y |
| | | | | | 200-250 | TMD-B4Y | PLG-B4Y |
| | | | | | 380-415 | TMD-B5Y | PLG-B5Y |
| | | | 3P+T | | 200-250 | TMD-B4X | PLG-B4X |
| | | | | | 380-415 | TMD-B5X | PLG-B5X |
| | | | | | 480-500 | TMD-B6X | PLG-B6X |
| | | | 3P+T+N | | 200-250 | TMD-B4W | PLG-B4W |
| | | | | | 380-415 | TMD-B5W | PLG-B5W |
| | | | | | 480-500 | TMD-B6W | PLG-B6W |
| 63 A | CORRENTE | | 3P+T | | 200-250 | TMD-C4X | PLG-C4X |
| | | | | | 380-415 | TMD-C5X | PLG-C5X |
| | | | | | 480-500 | TMD-C6X | PLG-C6X |
| | | | 3P+T+N | | 380-415 | TMD-C5W | PLG-C5W |
| | | | | | 480-500 | TMD-C6W | PLG-C6W |

DIMENSÕES

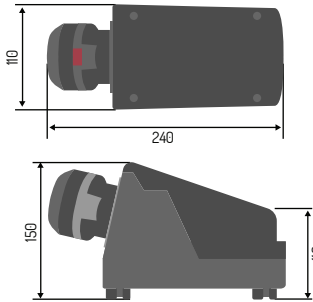

TOMADA/PLUG 16A

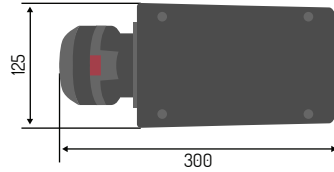
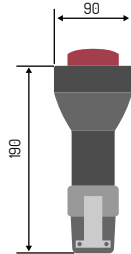

TOMADA/PLUG 32A

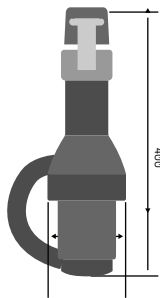
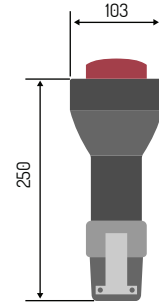
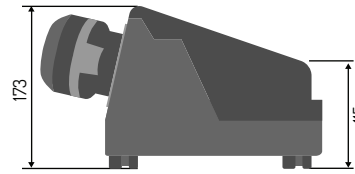

TOMADA/PLUG 63A

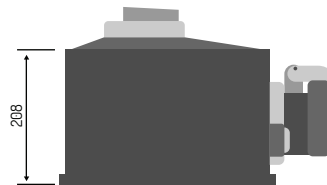
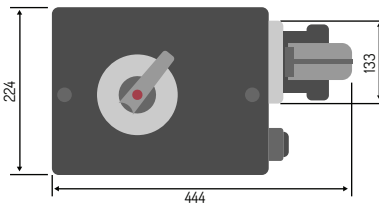

CÓDIGO

